

Cim EMV212/146

ATTUATORE A 3 PUNTI DI CONTROLLO PER Cim 776 - 24 V - DN15÷32



Realizzato in ottemperanza ai requisiti gestionali della norma EN ISO 9001.
Accessorio/Ricambio originale per prodotti Cimberio.

Garanzia 2 anni.

DISEGNO TECNICO E TABELLA

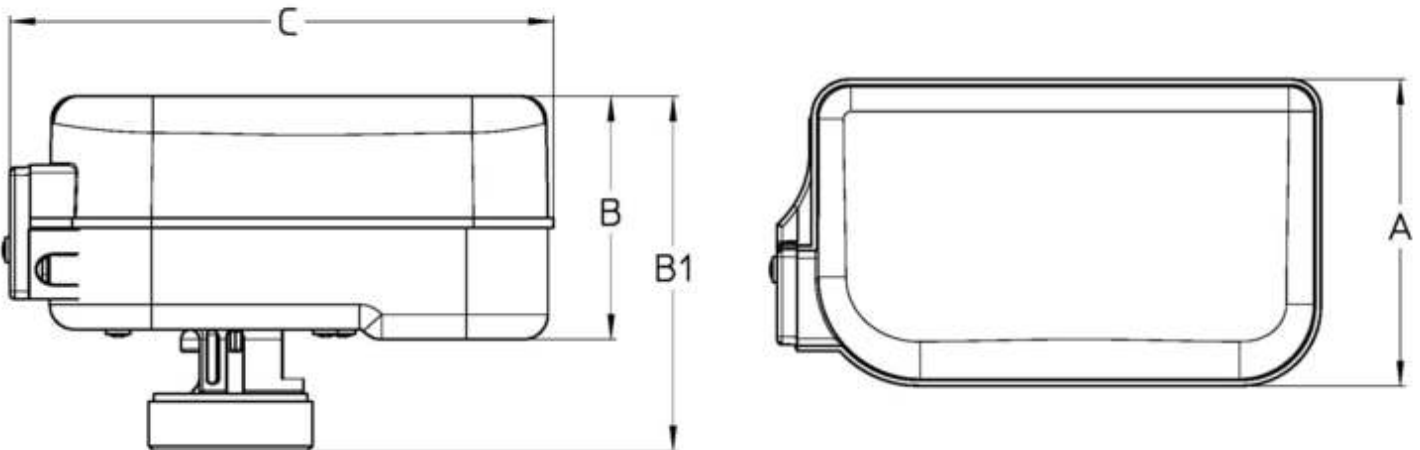

Grms.	325
A	62
B	48
B1	71,5
C	112

Filettatura:
M30x1.5

CARATTERISTICHE TECNICHE

collegamento ON-OFF / ON-OFF connection

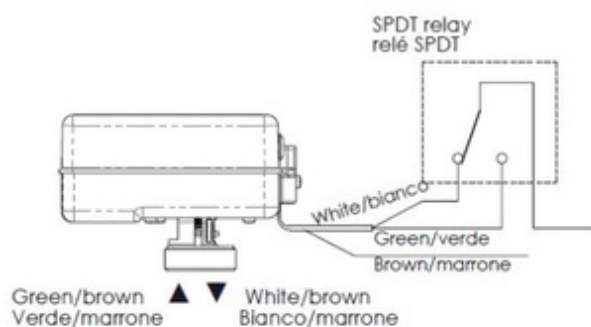

collegamento a 3 punti / 3-point connection

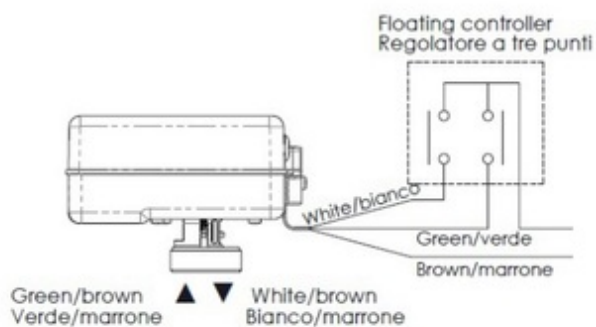

Voltage	24 V AC (50/60 Hz)
Power	2,2 VA - 2,2 W
IP	43
Control	3P
Force	300 N